

# BLJ85 防爆连接器

BLJ85  
Explosion-proof Connector



## 应用场所 Application

- 广泛应用于海洋工程各类作业平台、各类化学品、天然气运输船、危险品码头等危险区域的仪器或设备实现电路的连接；
- 可在潮湿、振动、腐蚀等恶劣环境中可靠工作；
- 适用于爆炸性危险环境1区、2区、21区、22区等场所。
- Widely used on various marine platforms, chemical tankers, LNG ships and dangerous cargo wharfs for electric connection of instrument or equipment.
- Can reliably work in severe environment where is easily affected by moisture, vibration, or corrosion;
- Explosive hazardous atmosphere Zone 1, Zone 2, Zone 21, Zone 22.

## 型号含义 Catalogue number logic

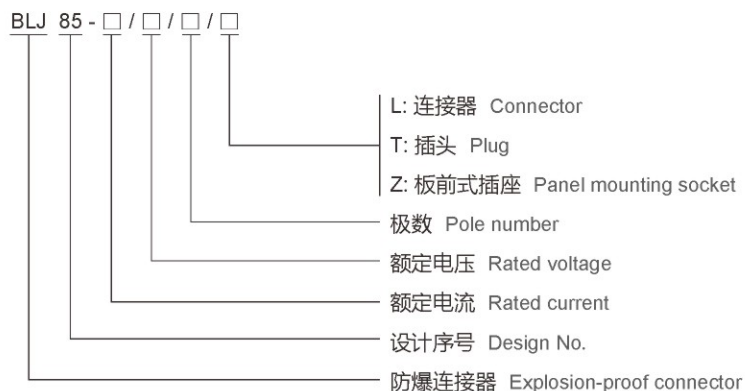

## 产品特性 Features

- 外壳采用优质铝合金材质，表面阳极氧化处理，耐腐蚀；
  - 连接后采用螺纹锁紧方式，具有防振、防松脱功能，并有效防止误插拔；
  - 高导电性接触件，插接后接触可靠；
  - 插芯材料为热塑性工程塑料绝缘，V0级阻燃；
  - 外观造型优美；
  - 形式有插头、插座、连接器、板前式插座多样。
  - 连接器可与危险区域的电气设备方便快速的连接，安全可靠，容易分断。
- Enclosure is high-quality aluminum alloy, with anodized surface, corrosion resistance;
  - Threaded locking after being well connected, anti-shock, anti-looseness, and can effectively prevent accidental pulling out or insertion;
  - Highly conductive contact, reliable contact after insertion;
  - Core material is insulating thermoplastics engineering plastic, V0 level flame retardant;
  - Beautiful appearance;
  - In the form of plugs, sockets, connectors, panel mounting socket etc.;
  - Connector can be quickly connected to the electric equipments which are located in hazardous areas, with safety, reliable and easy breaking performance.

## 技术参数 Technical parameters

执行标准 Conformity to standards	IEC 60079, EN 60079, GB/T 3836, CCS 入级规范 (CCS standard)				
防爆标志 Ex-Mark	Ex db eb IIC T6 Gb Ex tb IIIC T80°C Db	Ex db eb IIC T4 Gb Ex tb IIIC T80°C Db			Ex db IIC T4 Gb Ex tb IIIC T80°C Db
额定电压 Rated voltage	AC110~130V, AC200~250V, AC380~400V, AC/DC12~24V, AC/DC36~50V	AC200~250V, AC380~415V, AC480~500V, AC600~690V, DC24~50V			AC200~250V, AC380~415V, AC480~500V, AC600~690V
额定电流 Rated current	10A、16A	25A、32A	63A、80A	100A、125A	160A、200A
防护等级 Degree of protection	IP66				
防腐等级 Corrosion-proof	WF2				
极数 Pole number	2, 3, 4, 5	4, 5			4, 5
适用电缆 Cable O.D.	Φ8~Φ14mm	Φ17~Φ24mm	Φ22~Φ32mm	Φ28~Φ41mm	Φ33~Φ48mm

## 外形尺寸 Outline dimension

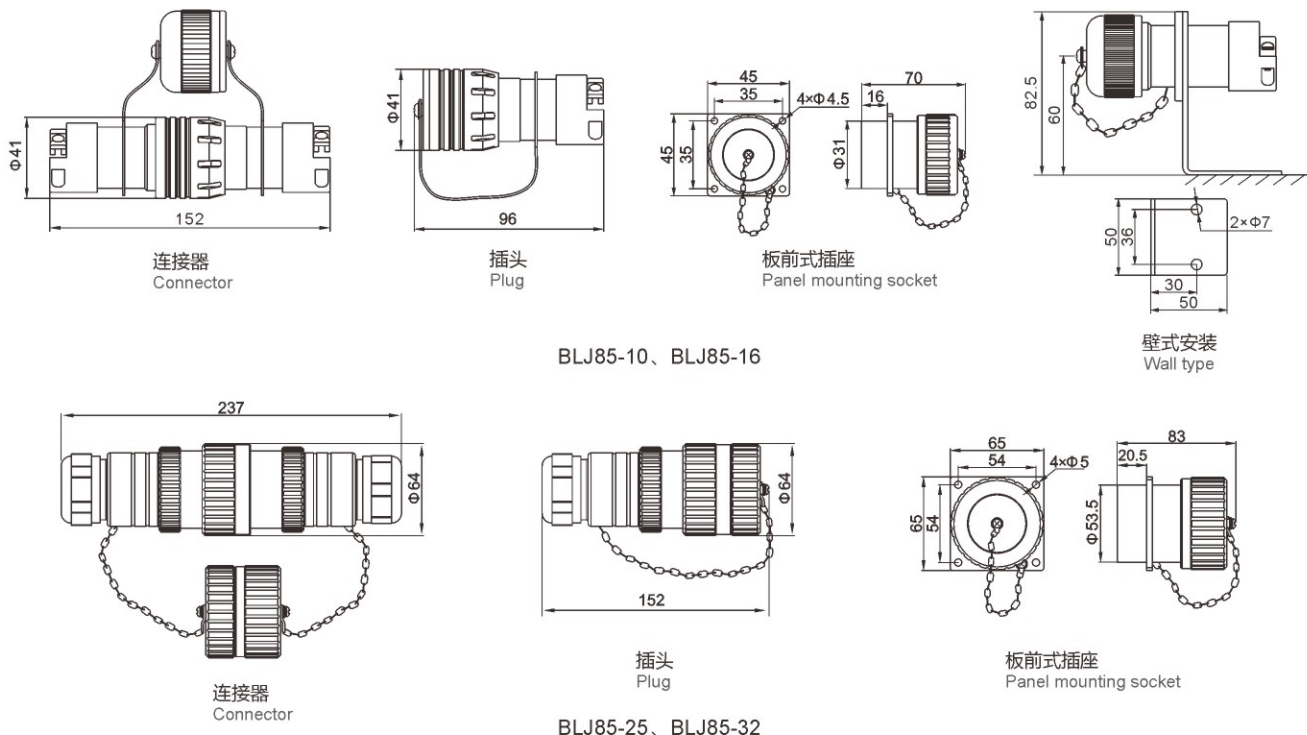

# BLJ85 防爆连接器

BLJ85 Explosion-proof Connector

## 外形尺寸 Outline dimension

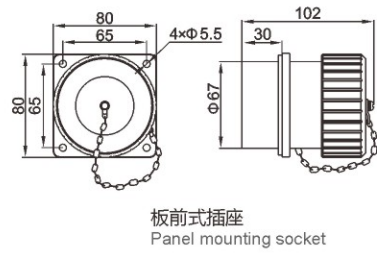
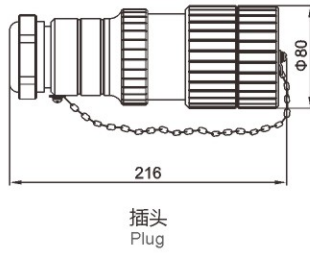
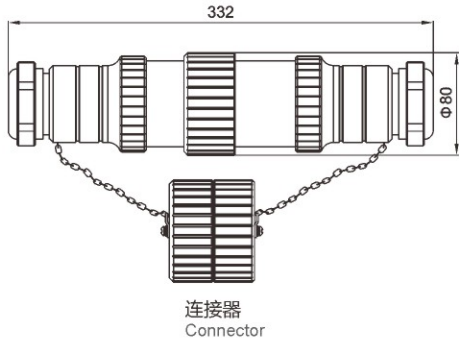

BLJ85-63、BLJ85-80

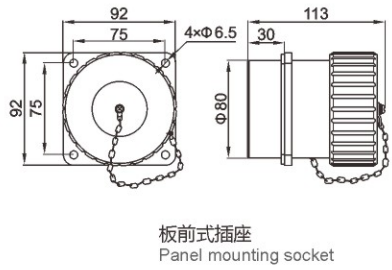
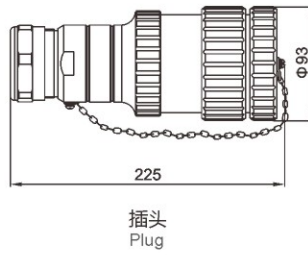
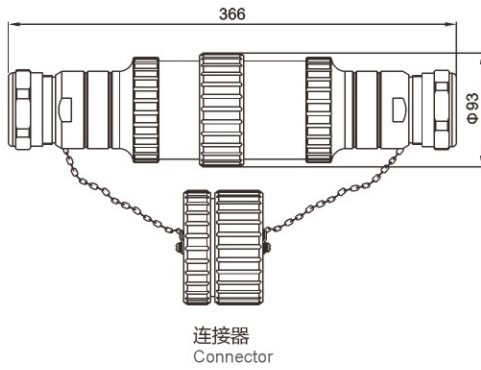

BLJ85-100、BLJ85-125

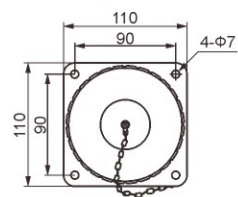
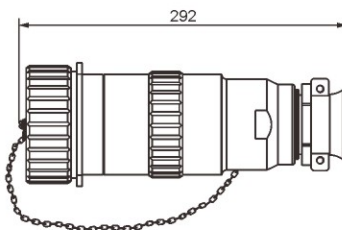
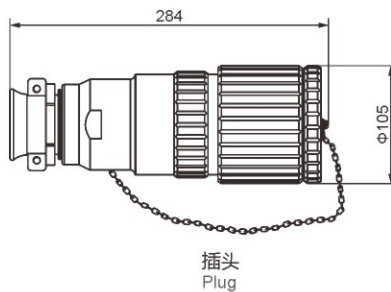
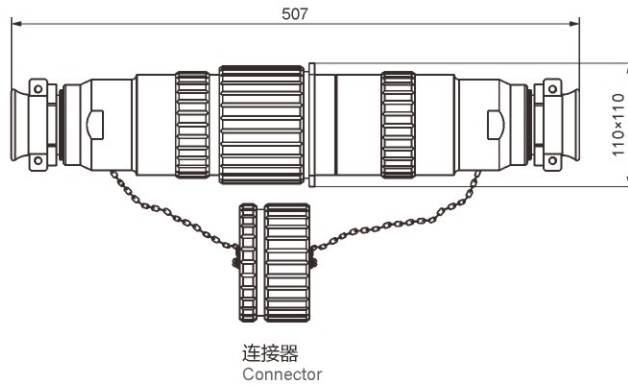

BLJ85-160、BLJ85-200