

Distribution Boxes

HRMD96 Series Explosion-proof Distribution Panels

- ◆ Explosion protection to
 - CENELEC
 - IEC
 - NEC
- ◆ Can be used in
 - Zone 1 and Zone 2
 - Zone 21 and Zone 22
 - Class I, Zone 1 and Zone 2
 - Class I, Division 1, Groups B, C, D
- ◆ Flameproof enclosure (Ex db), which can be used as feed distribution equipment in control and distribution system (such as distribution box, switch box of main circuit ,control box, terminal box or motor starting box etc.)
- ◆ Enclosure: 304 stainless steel, 316L stainless steel and Q235.
- ◆ Equipped with specialized hinge structure, which can prevent the flameproof joints from damage when opening and closing the box, and greatly prolong the service life of box.
- ◆ The boxes can be combined and installed freely to save space and meet the requirements of various distribution systems.
- ◆ Special requirements on request.
- ◆ The intelligent distribution panel is equipped with remote transmission capabilities, supporting intelligent control, interconnection and coordination, data monitoring, and early warning protection, and offers various Internet of Things (IoT) interface options. Intelligent functions can be customized according to user requirements.



■ Catalogue number logic

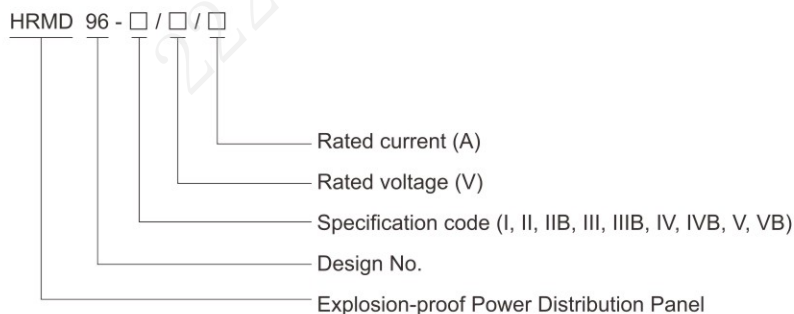

Zones 1 & 2; 21 & 22

Distribution Boxes

HRMD96 Series Explosion-proof Distribution Panels

Technical data

Explosion-proof distribution panels HRMD96-□/□/□

Explosion protection

Global (IECEX)

Gas and dust

IECEX PCET 24.0027X

Ex db IIC T6...T4¹ Gb

Ex db [ia Ga] IIC T6...T4¹ Gb

Ex db [ib Gb] IIC T6...T4¹ Gb

Ex tb IIIC T80°C...T130°C¹ Db

Ex tb [ia Da] IIIC T80°C...T130°C¹ Db

Ex tb [ib Db] IIIC T80°C...T130°C¹ Db

Europe (ATEX)

Gas and dust

TÜV CY 25 ATEX 0207340X

⊕ II 2 G Ex db IIC T6...T4¹ Gb

⊕ II 2 G Ex db [ia Ga] IIC T6...T4¹ Gb

⊕ II 2 G Ex db [ib Gb] IIC T6...T4¹ Gb

⊕ II 2 D Ex tb IIIC T80°C...T130°C¹ Db

⊕ II 2 D Ex tb [ia Da] IIIC T80°C...T130°C¹ Db

⊕ II 2 D Ex tb [ib Db] IIIC T80°C...T130°C¹ Db

See Selection table, P6/47~48

Certificates

IECEX; ATEX; CU-TR

Conformity to standards

EN IEC 60079-0, EN 60079-1, EN 60079-11, EN 60079-31

IEC 60079-0, IEC 60079-1, IEC 60079-11, IEC 60079-31

304 stainless steel, 316L stainless steel and Q235

Enclosure material

Exposed fastener

Stainless steel

Built-in components

Ammeters voltmeters, power meters, tachometers temperature control meters and other meters, control switches, disconnecting switches, Moulded Case Circuit Breakers (MCCB), Miniature Circuit Breakers(MCB), AC contactors, thermal relays, intermediate relays, time relays, control transformers, DC power supplies, current transformers, surge protectors, PLCs, fuses, soft starters, frequency converters, terminals, bus bars, resistors, light-operated switches, time controllers, optical fiber control boxes, magnet valves, analytical instruments, heaters, self-regulation trace heating cables, display screens, magnetic ballasts of HID light sources, electronic ballasts of fluorescent lamps, drivers of LED light sources, emergency devices of HID light sources, emergency devices of fluorescent lamps, emergency devices of LED light sources, safety barriers, integrated protectors of motors, lighting building controllers, lighting energy saving controllers, fire monitoring controllers, temperature controllers, humidity controllers, current monitors, voltage monitors, motor protection switches, dual power transfer switches, counters, timers, solid state relays, diode modules, industrial personal computers, UPS, batteries.

Rated voltage

Max. 1000V AC 50/60Hz Max. 1500V DC

Rated current

Max. 1000A

Degree of protection

IP66

Ambient temperature

-60°C(-40°C)~+60°C(+40°C), -40°C~+60°C(+40°C)

Cable entries

Standard M□×1.5 plug (the size of entry hole should be processed in accordance with actual requirements), NPT □ plug on request.

Cable gland (optional)

DQM-II (Ex d) or DQM-III (Ex d) is recommended. Please see P6/24~39.

Entry direction

Bottom

Mounting

Surface type (standard)

Pedestal type (optional)



Distribution Boxes

HRMD96 Series Explosion-proof Distribution Panels

Selection table for max. dissipated power

Ta=60°C	HRMD96 with full metal cover without glass		
	T4(T130°C)	T5(T95°C)	T6(T80°C)
Type	Power (W)	Power (W)	Power (W)
HRMD96-I	101	51	22
HRMD96-II	145	73	31
HRMD96-IIB	168	84	41
HRMD96-III	148	74	36
HRMD96-IIIB	188	94	46
HRMD96-IV	190	95	49
HRMD96-IVB	239	119	56
HRMD96-V	279	139	55
HRMD96-VB	299	149	72

Ta=60°C	HRMD96 with metal cover with glass		
	T4(T130°C)	T5(T95°C)	T6(T80°C)
Type	Power (W)	Power (W)	Power (W)
HRMD96-I	101	51	19
HRMD96-II	150	75	30
HRMD96-IIB	155	77	38
HRMD96-III	215	108	38
HRMD96-IIIB	224	112	49
HRMD96-IV	187	93	48
HRMD96-IVB	251	125	53
HRMD96-V	290	145	52
HRMD96-VB	313	157	65

Ta=40°C	HRMD96 with full metal cover without glass		
	T4(T130°C)	T5(T95°C)	T6(T80°C)
Type	Power (W)	Power (W)	Power (W)
HRMD96-I	130	79	43
HRMD96-II	187	114	61
HRMD96-IIB	216	132	89
HRMD96-III	190	116	89
HRMD96-IIIB	242	148	99
HRMD96-IV	244	149	103
HRMD96-IVB	307	188	111
HRMD96-V	358	219	108
HRMD96-VB	384	235	158



Distribution Boxes

HRMD96 Series Explosion-proof Distribution Panels

Ta=40°C	HRMD96 with metal cover with glass		
	T4(T130°C)	T5(T95°C)	T6(T80°C)
Type	Power (W)	Power (W)	Power (W)
HRMD96-I	130	79	38
HRMD96-II	193	118	52
HRMD96-IIB	199	122	65
HRMD96-III	277	169	78
HRMD96-IIIB	288	176	86
HRMD96-IV	240	147	87
HRMD96-IVB	322	197	95
HRMD96-V	373	228	93
HRMD96-VB	403	246	120

Dimension drawings (all dimensions in mm) - subject to alteration

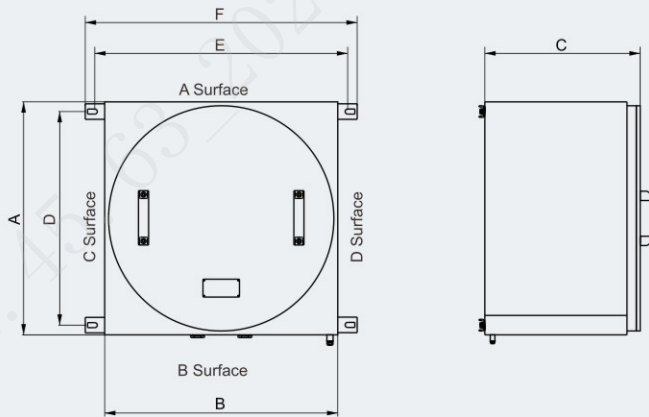

Version	Dimension (mm)						Weight (kg)
	A	B	C	D	E	F	
HRMD96-I	200	200	150	150	226	260	12.0
HRMD96-II	300	300	150	250	351	400	23.0
HRMD96-IIB	300	300	250	250	351	400	27.5
HRMD96-III	400	400	150	350	451	500	36.5
HRMD96-IIIB	400	400	250	350	451	500	53.0
HRMD96-IV	500	500	250	450	561	600	76.0
HRMD96-IVB	500	500	400	450	561	600	90.5
HRMD96-V	600	600	250	550	651	700	85.0
HRMD96-VB	600	600	400	550	651	700	128.0

Note: For cable entries:

- 1). Please specify the direction and size of each cable entry.
- 2). Cable gland is optional, DQM-II (Ex d) or DQM-III (Ex d) is recommended, please see P6/24~39.

Distribution Boxes HRMD96 Series Explosion-proof Distribution Panels

Typical scheme diagram

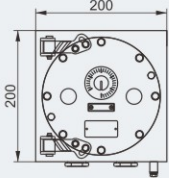
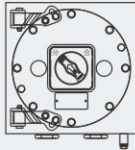
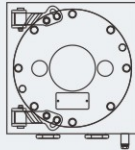
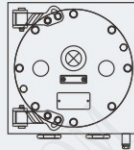
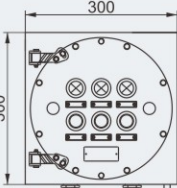
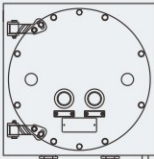
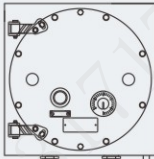
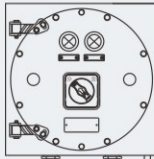
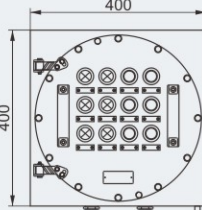
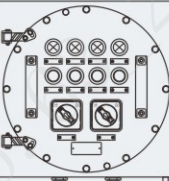
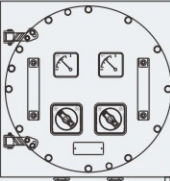
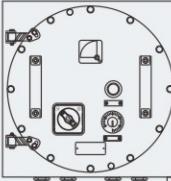
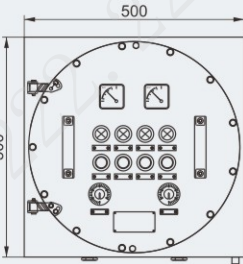
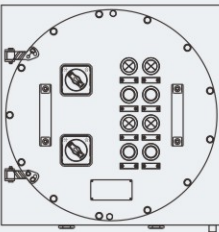
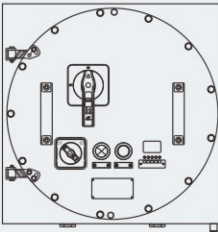
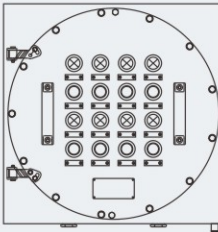
Enclosure	Components arrangement			
HRMD96-I				
HRMD96-II HRMD96-IIB				
HRMD96-III HRMD96-IIIB				
HRMD96-IV HRMD96-IVB				
HRMD96-V HRMD96-VB	