

## Distribution Boxes

### HRMD97 Series Explosion-proof Distribution Panels



- ◆ Explosion protection to
  - CENELEC
  - IEC
  - NEC
- ◆ Can be used in
  - Zone 1 and Zone 2
  - Zone 21 and Zone 22
  - Class I, Zone 1 and Zone 2
  - Class I, Division 1, Groups B, C, D
- ◆ Flameproof enclosure (Ex db, Ex db eb), which can be used as feed distribution equipment in control and distribution system (such as distribution box, switch box of main circuit, control box, terminal box or motor starting box etc.)
- ◆ Enclosure: Copper-free Aluminium Alloy, powder coated surface.
- ◆ Equipped with specialized hinge structure, which can prevent the flameproof joints from damage when opening and closing the box, and greatly prolong the service life of box.
- ◆ The boxes can be combined and installed freely to save space and meet the requirements of various distribution systems.
- ◆ Special requirements on request.

#### ■ Catalogue number logic

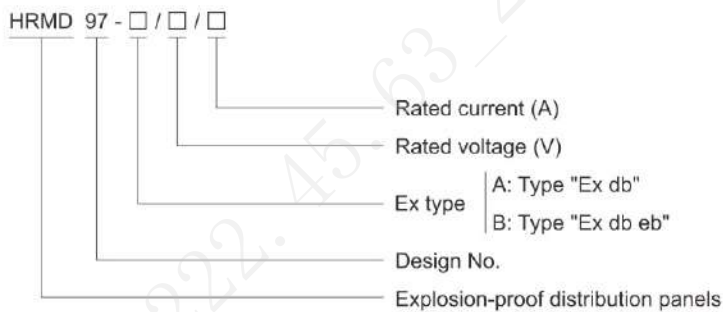

## Distribution Boxes

### HRMD97 Series Explosion-proof Distribution Panels

Technical data	
Explosion-proof distribution panels HRMD97-□/□/□	
<b>Explosion protection</b>	
Global (IECEX) Gas and dust	IECEX (applied for) Ex db IIC T6...T4 Gb Ex db eb IIC T6...T4 Gb Ex db [ia Ga] IIC T6...T4 Gb Ex db eb [ia Ga] IIC T6...T4 Gb Ex db [ib Gb] IIC T6...T4 Gb Ex db eb[ib Gb] IIC T6...T4 Gb Ex tb IIIC T80°C...T130°C Db Ex tb [ia Da] IIIC T80°C...T130°C Db Ex tb [ib Db] IIIC T80°C...T130°C Db
Europe (ATEX) Gas and dust	ATEX (applied for) ⊕ II 2 G Ex db IIC T6...T4 Gb ⊕ II 2 G Ex db eb IIC T6...T4 Gb ⊕ II 2 G Ex db [ia Ga] IIC T6...T4 Gb ⊕ II 2 G Ex db eb [ia Ga] IIC T6...T4 Gb ⊕ II 2 G Ex db [ib Gb] IIC T6...T4 Gb ⊕ II 2 G Ex db eb [ib Gb] IIC T6...T4 Gb ⊕ II 2 D Ex tb IIIC T80°C...T130°C Db ⊕ II 2 D Ex tb [ia Da] IIIC T80°C...T130°C Db ⊕ II 2 D Ex tb [ib Db] IIIC T80°C...T130°C Db
<b>Certificates</b>	IECEX; ATEX
<b>Conformity to standards</b>	EN IEC 60079-0, EN 60079-1, EN 60079-7, EN 60079-11, EN 60079-31 IEC 60079-0, IEC 60079-1, IEC 60079-7, IEC 60079-11, IEC 60079-31
<b>Enclosure material</b>	Copper-free Aluminium Alloy, powder coated surface
<b>Exposed fastener</b>	Stainless steel
<b>Built-in components</b>	Ammeters voltmeters, power meters, tachometers temperature control meters and other meters, control switches, disconnecting switches, Moulded Case Circuit Breakers (MCCB), Miniature Circuit Breakers(MCB), AC contactors, thermal relays, intermediate relays, time relays, control transformers, DC power supplies, current transformers, surge protectors, PLCs, fuses, soft starters, frequency converters, terminals, bus bars, resistors, light-operated switches, time controllers, optical fiber control boxes, magnet valves, analytical instruments, heaters, self-regulation trace heating cables, display screens, magnetic ballasts of HID light sources, electronic ballasts of fluorescent lamps, drivers of LED light sources, emergency devices of HID light sources, emergency devices of fluorescent lamps, emergency devices of LED light sources, safety barriers, integrated protectors of motors, lighting building controllers, lighting energy saving controllers, fire monitoring controllers, temperature controllers, humidity controllers, current monitors, voltage monitors, motor protection switches, dual power transfer switches, counters, timers, solid state relays, diode modules, industrial personal computers, UPS, batteries.
<b>Rated voltage</b>	Max. 1000V AC 50/60Hz Max. 1500V DC
<b>Rated current</b>	Max. 1000A
<b>Degree of protection</b>	IP66
<b>Ambient temperature</b>	-60°C(-40°C)~+60°C(+40°C), -40°C~+60°C(+40°C)
<b>Cable entries</b>	Standard M□×1.5 plug (the size of entry hole should be processed in accordance with actual requirements), NPT □ plug on request.
<b>Cable gland (optional)</b>	DQM-I (Ex e) or DQM-II (Ex d) or DQM-III (Ex d) is recommended. Please see P6/20~39.
<b>Entry direction</b>	Bottom
<b>Mounting</b>	Surface type (standard), Pedestal type (optional)



## Distribution Boxes HRMD97 Series Explosion-proof Distribution Panels

Dimension drawings (Ex db)(Single body) (all dimensions in mm) - subject to alteration

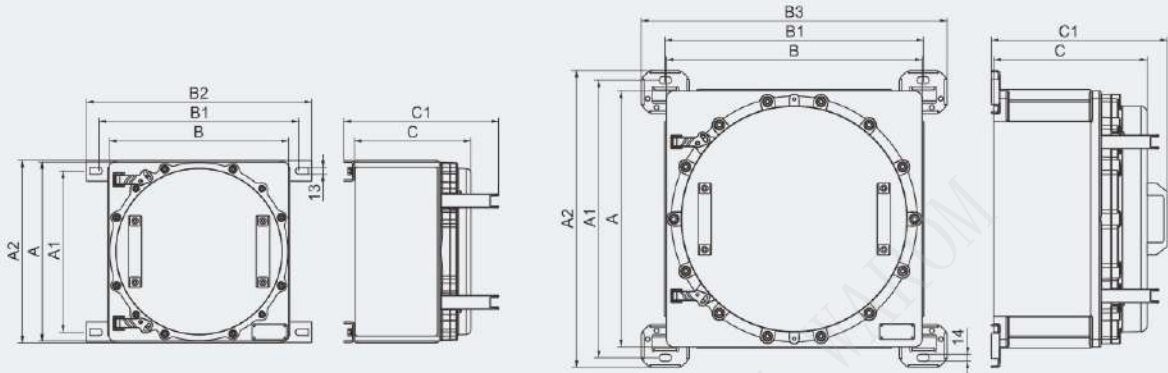

Version	Dimension (mm)							
	A	B	C	A1	A2	B1	B2	C1
250×250	250	250	168	212	252	290	340	188
350×350	250	250	228	315	356	190	440	188
500×500	500	500	300	542	580	504	597	344
600×600	600	600	300	642	680	604	697	344

Note: For cable entries:

- 1). Please specify the direction and size of each cable entry.
- 2). Cable gland is optional, DQM-II (Ex d) or DQM-III (Ex d) is recommended, please see P6/24~39.



### Typical scheme diagram (Ex db)(Single body)

Version	Components arrangement
250×250	
350×350	

Distribution Boxes  
HRMD97 Series Explosion-proof Distribution Panels

Typical scheme diagram (Ex db)(Single body)

Version	Components arrangement				
500×500					
	600×600				



## Distribution Boxes HRMD97 Series Explosion-proof Distribution Panels

Dimension drawings (Ex db) (all dimensions in mm) - subject to alteration

500×500 splicing body

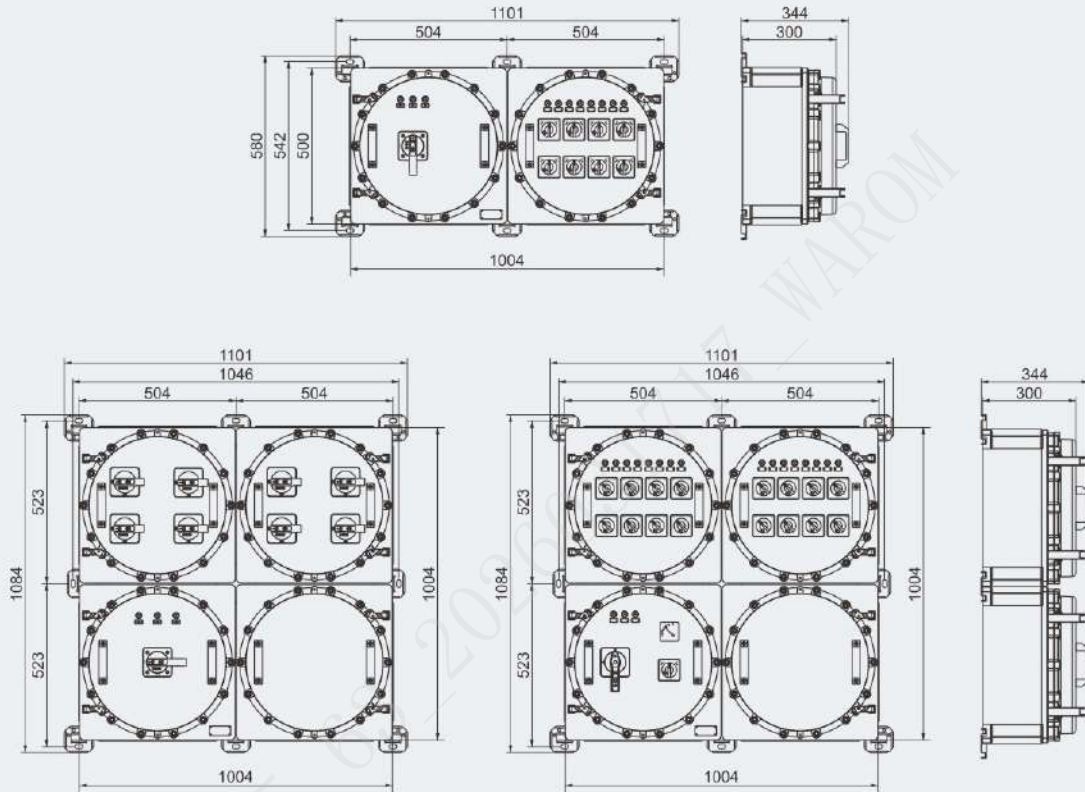

600×600 splicing body

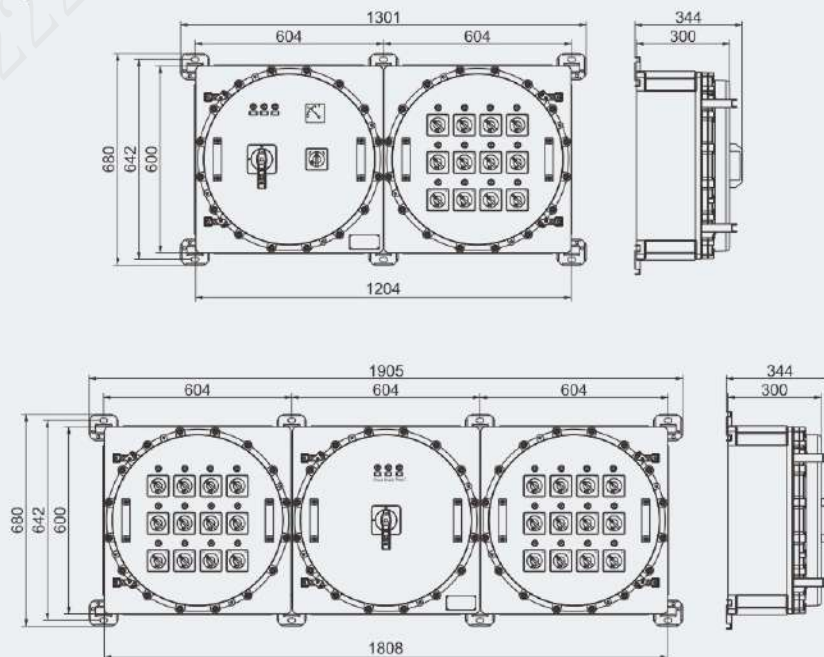

## Distribution Boxes HRMD97 Series Explosion-proof Distribution Panels

Dimension drawings (Ex db) (all dimensions in mm) - subject to alteration

600×600 splicing body

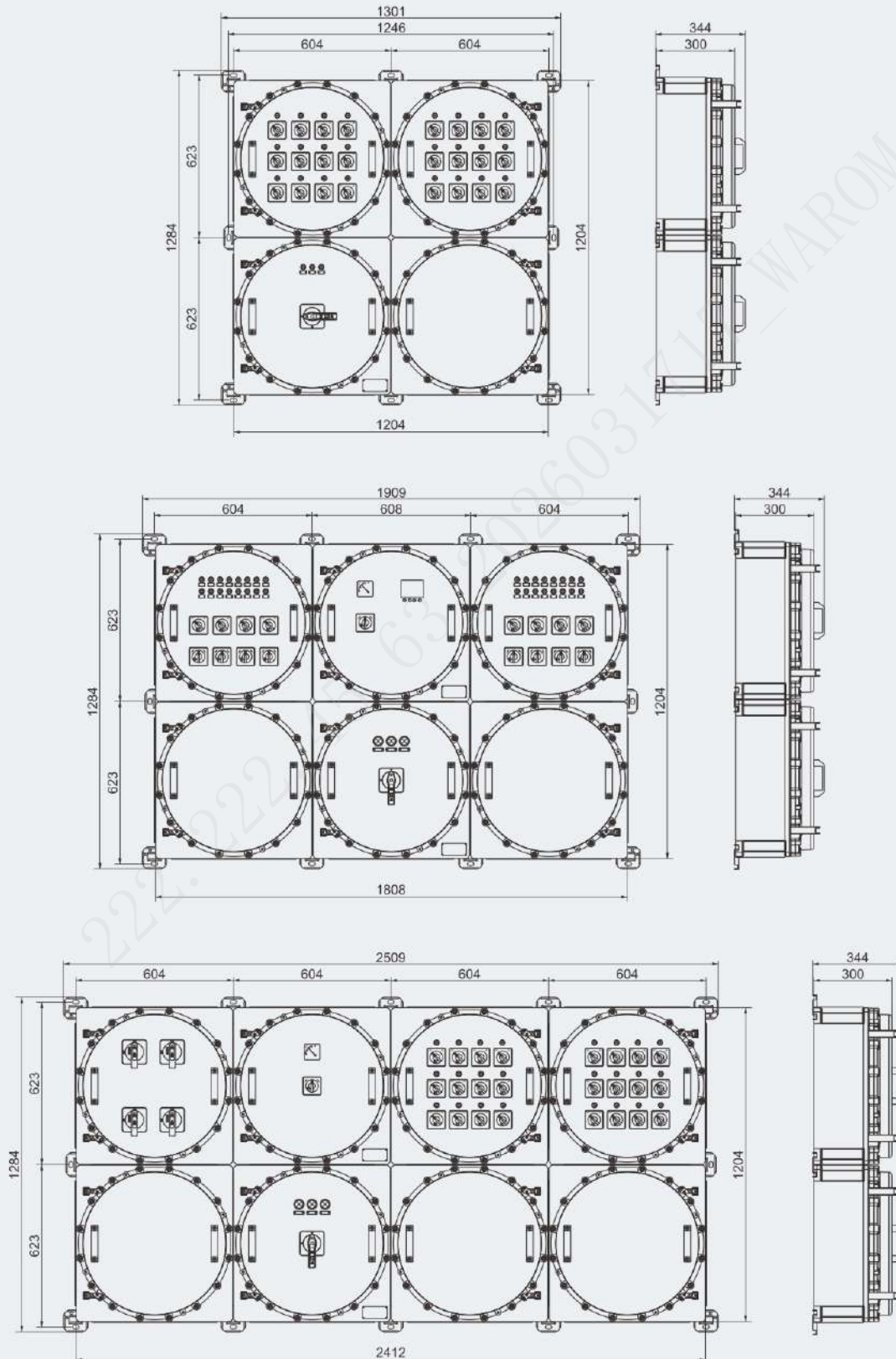

## Distribution Boxes HRMD97 Series Explosion-proof Distribution Panels

Dimension drawings (Ex db eb) (all dimensions in mm) - subject to alteration

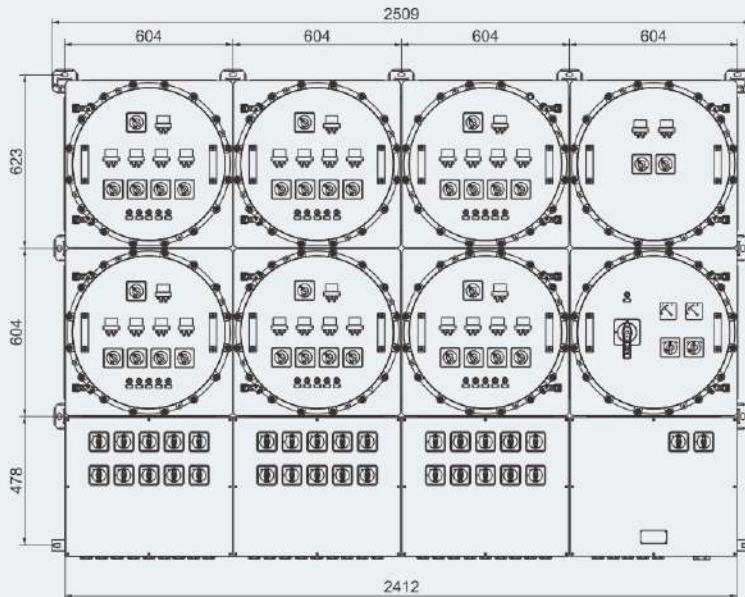
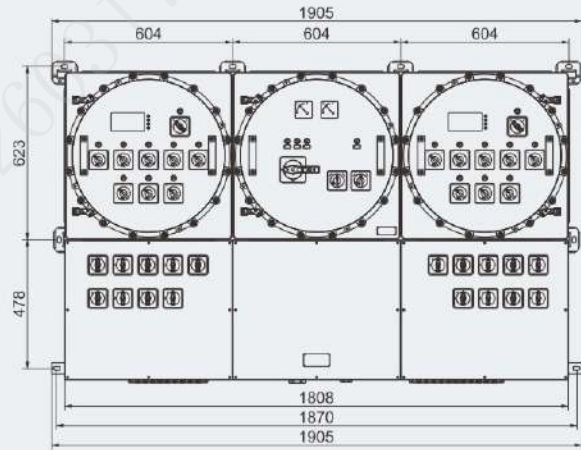
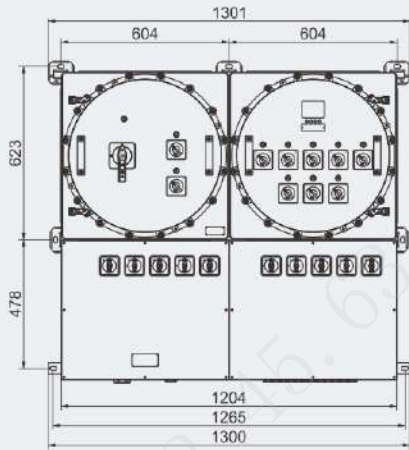
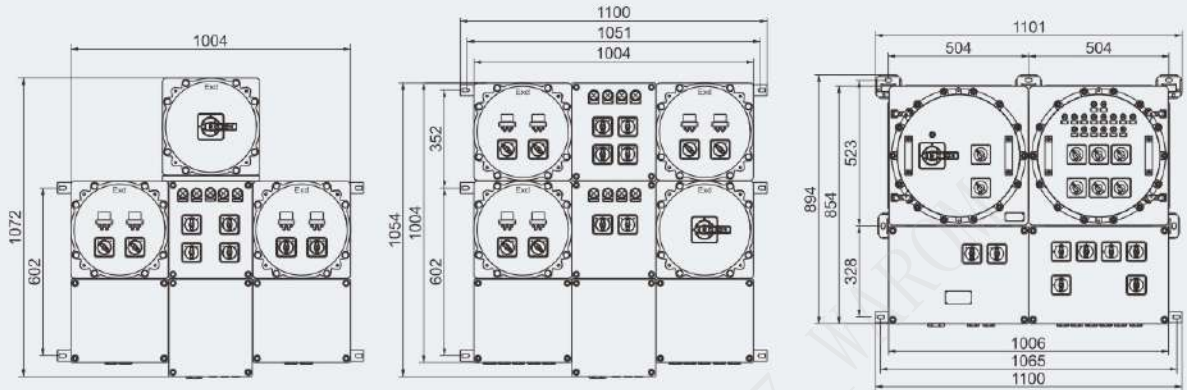

## Distribution Boxes HRMD97 Series Explosion-proof Distribution Panels

Dimension drawings (all dimensions in mm) - subject to alteration

Bracket type

