

Light Fittings for Fluorescent Lamp BAY51-Q LED Series Explosion-proof Light Fittings



- ◆ Explosion Protection to
 - CENELEC
 - IEC
 - NEC
- ◆ Can be used in
 - Zone 1 and Zone 2
 - Zone 21 and Zone 22
 - Class I, Zone 1 and Zone 2
 - Class I, Division 2, Groups A, B, C, D
- ◆ Enclosure size: Type I and Type II
- ◆ Available lamp and power
 - LED tubes:
 - Built-in power supply, LED lamp and driving power are integrated type: 9W×1, 18W×1, 9W×2, 18W×2;
 - External power supply, LED lamp and driving power are split type: 14W×1, 14W×2, 28W×1, 28W×2.
 - SMD LED: 20W, 40W, 60W, 80W
- ◆ Enclosure: GRP (glass fiber reinforced polyester).
Diffuser: PC (polycarbonate).
- ◆ Ex e enclosure with explosion-proof components inside.
- ◆ Interlock function between enclosure and diffuser, switches off on opening.
- ◆ Built-in LED driver, wide voltage input, CC-CV (constant current-constant voltage) output, power factor ≥0.95.
- ◆ Emergency unit with protections against overcharge and over-discharge.



Catalogue number logic

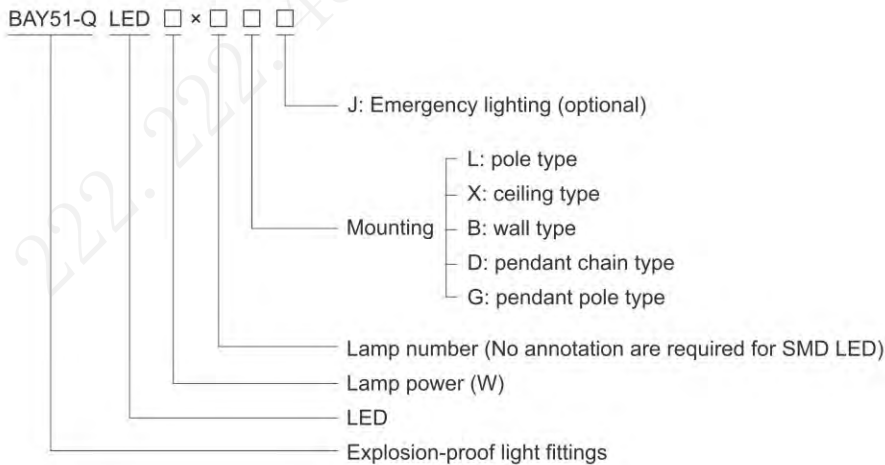

Zones 1&2; 21&22

Light Fittings for Fluorescent Lamp

BAY51-Q LED Series Explosion-proof Light Fittings

Technical data	
Explosion-proof light fittings with LED lamp tube BAY51-Q LED □×□□□	
Explosion protection	
Global (IECEX)	IECEX CQM 19.0013X
Gas and dust	Ex db eb IIC T6 Gb ¹⁾ Ex db eb q IIC T5 or T6 Gb ¹⁾ Ex tb IIIC T80°C Db ¹⁾
Europe (ATEX)	CML19 ATEX 1288X
Gas and dust	⊕ II 2 G Ex db eb IIC T6 Gb ¹⁾ ⊕ II 2 G Ex db eb q IIC T5 or T6 Gb ¹⁾ ⊕ II 2 D Ex tb IIIC T80°C Db ¹⁾
Certificates	¹⁾ See Selection Table
Conformity to standards	IECEX; ATEX; CU-TR; INMETRO EN 60079-0, EN 60079-1, EN 60079-5, EN 60079-7, EN 60079-31 IEC 60079-0, IEC 60079-1, IEC 60079-5, IEC 60079-7, IEC 60079-31
Material	
Enclosure	GRP, stands 7J impact, corrosion-proof
Diffuser	Polycarbonate, high light transmission, stands 7J impact
LED driver	Wide voltage input, CC-CV (constant current - constant voltage) output, power factor ≥0.95, with function of distributed current, constant current, surge-proof and anti-electromagnetic interference, and protection against overcurrent, open circuit, and short circuit. Certificate No.: CML 19 ATEX 5115U, CML 19 ATEX 5201U, IECEX CQM 19.0002U
Exposed fastener	Stainless steel
Lamp	
Lamp specification	LED lamp tube (supplied with the light fittings)
Lamp power (W)	9W×1, 18W×1, 9W×2, 18W×2 (LED lamp and driving power are integrated type) 14W×1, 28W×1, 14W×2, 28W×2 (LED lamp and driving power are split type) Certificate No.: CML 19 ATEX 1288X, IECEX CQM 19.0012U
Colour rendering index (Ra)	≥80
Colour temperature (CCT)	5000K Note: nature white is available in general. Warm white or cool white is optional, please specify when ordering.
Rated voltage	Built-in power supply, LED lamp and driving power are integrated type: 170~264V AC 50/60Hz External power supply, LED lamp and driving power are split type: 100~277V AC 50/60Hz; 200~250V DC
Degree of protection	IP66
Ambient temperature	Ex db eb IIC T6 Gb for Tamb: -40°C~+55°C Ex db eb q IIC T6 Gb for Tamb: -40°C~+45°C Ex db eb q IIC T5 Gb for Tamb: -40°C~+55°C Ex tb IIIC T80°C Db for Tamb: -40°C~+55°C ⊕ II 2 G Ex db eb IIC T6 Gb for Tamb: -40°C~+55°C ⊕ II 2 G Ex db eb q IIC T6 Gb for Tamb: -40°C~+45°C ⊕ II 2 G Ex db eb q IIC T5 Gb for Tamb: -40°C~+55°C ⊕ II 2 D Ex tb IIIC T80°C Db for Tamb: -40°C~+55°C
Terminal	3×1.5~4mm ² (L+N+PE)
Cable entries	Pole type: 1×Φ26: 1×M25×1.5 cable glands (DQM-I/I Ex eb, plastic). Other mounting methods: 2×Φ26: 2×M25×1.5 cable glands (DQM-I/I Ex eb, plastic). Φ9~Φ16 (mm)
Available cable outer diameter	
Emergency data	
Emergency controller	Special emergency controller and battery pack, with protection against overcharge and overdischarge.
Emergency power (W)	14W×30%, 28W×30%
Emergency starting time	0.3s
Charging time	24h
Emergency lighting time	120min (180min is optional)
Terminal	5×1.5~4mm ² (L1+N1+L1'+N1'+PE)



Selection table

Lamp tube type	LED lamp and driving power are integrated type	LED lamp and driving power are split type
Explosion protection	⊕ II 2 G Ex db eb IIC T6 Gb ⊕ II 2 D Ex tb IIIC T80°C Db	⊕ II 2 G Ex db eb q IIC T5 or T6 Gb ⊕ II 2 D Ex tb IIIC T80°C Db
Lamp power (W)	9W×1, 18W×1, 9W×2, 18W×2	14W×1, 28W×1, 14W×2, 28W×2

Light Fittings for Fluorescent Lamp

BAY51-Q LED Series Explosion-proof Light Fittings

Technical data

Explosion-proof light fittings with SMD LED BAY51-Q LED □□□

Explosion protection

Global (IECEX)
Gas and dust

IECEX CQM 19.0013X

Ex db eb mb IIC T6/T5 Gb¹⁾

Ex tb IIIC T80°C Db¹⁾

CML19 ATEX 1288X

Europe (ATEX)
Gas and dust

Ⓔ II 2 G Ex db eb mb IIC T6/T5 Gb¹⁾

Ⓔ II 2 D Ex tb IIIC T80°C Db¹⁾

¹⁾ See Selection Table

Certificates

IECEX; ATEX

Conformity to standards

EN 60079-0, EN 60079-1, EN 60079-7, EN 60079-18, EN 60079-31,
IEC 60079-0, IEC 60079-1, IEC 60079-7, IEC 60079-18, IEC 60079-31

Material

Enclosure
Diffuser
LED driver

GRP, stands 7J impact, corrosion-proof

Polycarbonate, high light transmission, stands 7J impact

Wide voltage input, CC-CV (constant current - constant voltage) output, power factor ≥ 0.95 , with function of distributed current, constant current, surge-proof and anti-electromagnetic interference, and protection against overcurrent, open circuit, and short circuit.

Stainless steel

Exposed fastener

Lamp

Lamp specification
Lamp power (W)
Colour rendering index (Ra)
Colour temperature (CCT)

SMD LED (supplied with the light fittings)

20W, 40W, 60W, 80W

≥ 80

5000K

Note: nature white is available in general. Warm white or cool white is optional, please specify when ordering.

Rated voltage

100-277V AC 50/60Hz 130-250V DC

Degree of protection

IP66

Ambient temperature

-40°C~+60°C(+55°C)(+45°C)¹⁾

¹⁾ See Selection Table

Terminal

3×1.5~4mm² (L+N+PE)

Cable entries

Pole type: 1×Φ26: 1×M25×1.5 cable glands (DQM-I/I Ex eb, plastic).

Other mounting methods: 2×Φ26: 2×M25×1.5 cable glands (DQM-I/I Ex eb, plastic).
Φ9~Φ16 (mm)

Available cable outer diameter

Emergency data

Emergency controller

Special emergency controller and battery pack, with protection against overcharge and overdischarge.

Emergency power (W)

20W×70%, 40W×35%, 60W×23%, 80W×18%

Emergency starting time

0.3s

Charging time

24h

Emergency lighting time

90min (180min is optional)

Terminal

5×1.5~4mm² (L1+N1+L1'+N1'+PE)

Selection table

Type / Ordering code	Temperature classification					
	-40°C≤Ta≤+45°C		-40°C≤Ta≤+55°C		-40°C≤Ta≤+60°C	
	Gas	Dust	Gas	Dust	Gas	Dust
BAY51-Q LED 20□, BAY51-Q LED 20□J BAY51-Q LED 40□, BAY51-Q LED 40□J	/	/	T6	T80°C	T5	T80°C
BAY51-Q LED 60□, BAY51-Q LED 60□J BAY51-Q LED 80□, BAY51-Q LED 80□J	T6	T80°C	T5	T80°C	/	/
	T5	T80°C	/	/	/	/



Light Fittings for Fluorescent Lamp

BAY51-Q LED Series Explosion-proof Light Fittings

Selection table for explosion-proof light fittings with LED tubes, split type

Type / Ordering code	Lamp power(W)	Weight (kg)	Type / Ordering code	Lamp power(W)	Weight (kg)	Type / Ordering code	Lamp power(W)	Weight (kg)	Type / Ordering code	Lamp power(W)	Weight (kg)
BAY51-Q LED14×1L	14×1	8.00	BAY51-Q LED14×1LJ	14×1	8.30	BAY51-Q LED14×2L	14×2	8.45	BAY51-Q LED14×2LJ	14×2	8.80
BAY51-Q LED14×1X	14×1	7.90	BAY51-Q LED14×1XJ	14×1	8.20	BAY51-Q LED14×2X	14×2	8.35	BAY51-Q LED14×2XJ	14×2	8.70
BAY51-Q LED14×1B	14×1	8.90	BAY51-Q LED14×1BJ	14×1	9.20	BAY51-Q LED14×2B	14×2	9.35	BAY51-Q LED14×2BJ	14×2	9.70
BAY51-Q LED14×1D	14×1	9.20	BAY51-Q LED14×1DJ	14×1	9.50	BAY51-Q LED14×2D	14×2	9.65	BAY51-Q LED14×2DJ	14×2	10.00
BAY51-Q LED14×1G	14×1	8.85	BAY51-Q LED14×1GJ	14×1	9.15	BAY51-Q LED14×2G	14×2	9.30	BAY51-Q LED14×2GJ	14×2	9.65
BAY51-Q LED28×1L	28×1	12.50	BAY51-Q LED28×1LJ	28×1	13.65	BAY51-Q LED28×2L	28×2	12.90	BAY51-Q LED28×2LJ	28×2	14.15
BAY51-Q LED28×1X	28×1	13.20	BAY51-Q LED28×1XJ	28×1	14.45	BAY51-Q LED28×2X	28×2	13.70	BAY51-Q LED28×2XJ	28×2	14.95
BAY51-Q LED28×1B	28×1	13.30	BAY51-Q LED28×1BJ	28×1	14.55	BAY51-Q LED28×2B	28×2	13.80	BAY51-Q LED28×2BJ	28×2	15.05
BAY51-Q LED28×1D	28×1	13.55	BAY51-Q LED28×1DJ	28×1	14.80	BAY51-Q LED28×2D	28×2	14.00	BAY51-Q LED28×2DJ	28×2	15.30
BAY51-Q LED28×1G	28×1	13.20	BAY51-Q LED28×1GJ	28×1	14.45	BAY51-Q LED28×2G	28×2	13.70	BAY51-Q LED28×2GJ	28×2	14.95

Note: Products above include all the mounting accessories listed in Mounting Accessories & Spare Parts Table (see P2/14~15).

Selection table for explosion-proof light fittings with LED tubes, integrated type

Type / Ordering code	Lamp power(W)	Weight (kg)	Type / Ordering code	Lamp power(W)	Weight (kg)
BAY51-Q LED9×1L	9×1	7.50	BAY51-Q LED9×2L	9×2	8.50
BAY51-Q LED9×1X	9×1	7.40	BAY51-Q LED9×2X	9×2	8.00
BAY51-Q LED9×1B	9×1	8.40	BAY51-Q LED9×2B	9×2	9.00
BAY51-Q LED9×1D	9×1	8.60	BAY51-Q LED9×2D	9×2	9.00
BAY51-Q LED9×1G	9×1	8.40	BAY51-Q LED9×2G	9×2	9.00
BAY51-Q LED18×1L	18×1	12.00	BAY51-Q LED18×2L	18×2	12.40
BAY51-Q LED18×1X	18×1	12.70	BAY51-Q LED18×2X	18×2	13.30
BAY51-Q LED18×1B	18×1	12.80	BAY51-Q LED18×2B	18×2	13.30
BAY51-Q LED18×1D	18×1	13.00	BAY51-Q LED18×2D	18×2	13.60
BAY51-Q LED18×1G	18×1	12.70	BAY51-Q LED18×2G	18×2	13.20

Note: Products above include all the mounting accessories listed in Mounting Accessories & Spare Parts Table (see P2/14~15).

Selection table for explosion-proof light fittings with SMD LED

Type / Ordering code	Lamp power(W)	Weight (kg)	Type / Ordering code	Lamp power(W)	Weight (kg)	Type / Ordering code	Lamp power(W)	Weight (kg)	Type / Ordering code	Lamp power(W)	Weight (kg)
BAY51-Q LED20L	20	6.20	BAY51-Q LED40L	40	6.40	BAY51-Q LED60L	60	10.40	BAY51-Q LED80L	80	10.80
BAY51-Q LED20X	20	6.10	BAY51-Q LED40X	40	6.30	BAY51-Q LED60X	60	10.30	BAY51-Q LED80X	80	10.70
BAY51-Q LED20B	20	7.10	BAY51-Q LED40B	40	7.30	BAY51-Q LED60B	60	11.30	BAY51-Q LED80B	80	11.70
BAY51-Q LED20D	20	7.30	BAY51-Q LED40D	40	7.50	BAY51-Q LED60D	60	11.50	BAY51-Q LED80D	80	11.90
BAY51-Q LED20G	20	7.10	BAY51-Q LED40G	40	7.30	BAY51-Q LED60G	60	11.30	BAY51-Q LED80G	80	11.70
BAY51-Q LED20LJ	20	7.70	BAY51-Q LED40LJ	40	12.00	BAY51-Q LED60LJ	60	12.00	BAY51-Q LED80LJ	80	12.40
BAY51-Q LED20XJ	20	7.60	BAY51-Q LED40XJ	40	11.90	BAY51-Q LED60XJ	60	11.90	BAY51-Q LED80XJ	80	12.30
BAY51-Q LED20BJ	20	8.60	BAY51-Q LED40BJ	40	12.90	BAY51-Q LED60BJ	60	12.90	BAY51-Q LED80BJ	80	13.30
BAY51-Q LED20DJ	20	8.80	BAY51-Q LED40DJ	40	13.10	BAY51-Q LED60DJ	60	13.10	BAY51-Q LED80DJ	80	13.50
BAY51-Q LED20GJ	20	8.60	BAY51-Q LED40GJ	40	12.90	BAY51-Q LED60GJ	60	12.90	BAY51-Q LED80GJ	80	13.30

Note: Products above include all the mounting accessories listed in Mounting Accessories & Spare Parts Table (see P2/14~15).



Light Fittings for Fluorescent Lamp BAY51-Q LED Series Explosion-proof Light Fittings

Photometric data Note: LED luminous flux is from the standard product of which colour temperature is 5000K

BAY51-Q LED 14×1 □□

Lamp power (W)	Luminous flux	Wattage
14×1	1947lm	14.3W

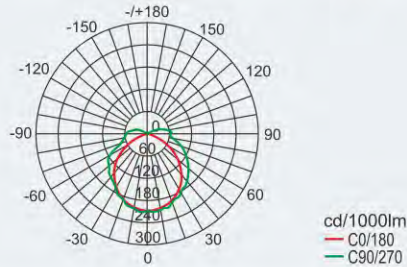

BAY51-Q LED 28×1 □□

Lamp power (W)	Luminous flux	Wattage
28×1	4000lm	27.4W

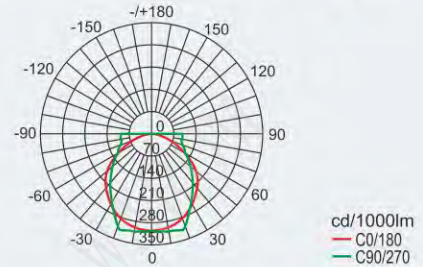

BAY51-Q LED 14×2 □□

Lamp power (W)	Luminous flux	Wattage
14×2	3894lm	28.6W

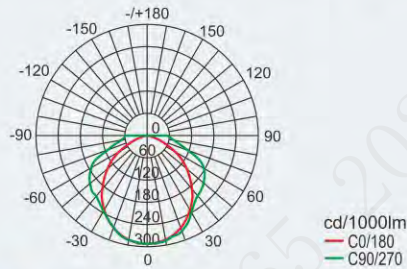

BAY51-Q LED 28×2 □□

Lamp power (W)	Luminous flux	Wattage
28×2	7995lm	54.8W

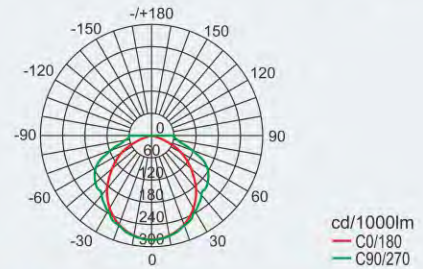

BAY51-Q LED 9×1 □

Lamp power (W)	Luminous flux	Wattage
9×1	1322lm	8.5W

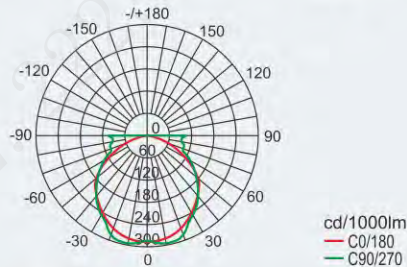

BAY51-Q LED 18×1 □

Lamp power (W)	Luminous flux	Wattage
18×1	2780lm	18W

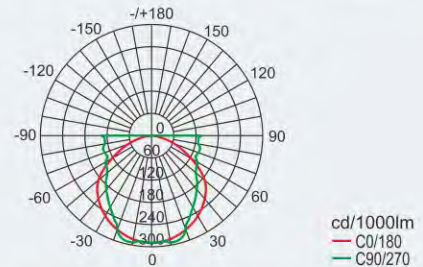

BAY51-Q LED 9×2 □

Lamp power (W)	Luminous flux	Wattage
9×2	2643lm	17.4W

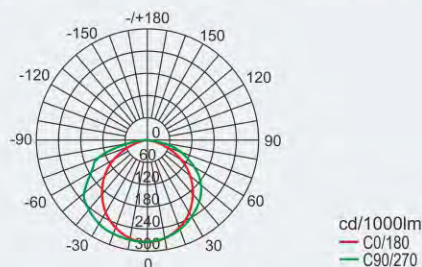

BAY51-Q LED 18×2 □

Lamp power (W)	Luminous flux	Wattage
18×2	5561lm	36W

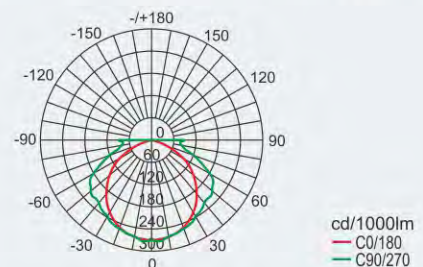

We can provide lighting design and data by professional lighting software DIALUX based upon simulated site situation on request.

Light Fittings for Fluorescent Lamp BAY51-Q LED Series Explosion-proof Light Fittings

Photometric data Note: LED luminous flux is from the standard product of which colour temperature is 5000K

BAY51-Q LED 20 □□

Lamp power (W)	Luminous flux	Wattage
20	2300lm	21W

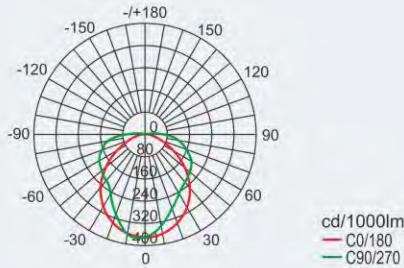

BAY51-Q LED 40 □□

Lamp power (W)	Luminous flux	Wattage
40	5100lm	44W

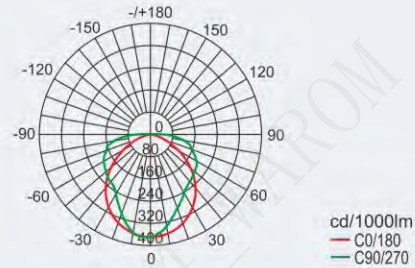

BAY51-Q LED 60 □□

Lamp power (W)	Luminous flux	Wattage
60	6900lm	57.3W

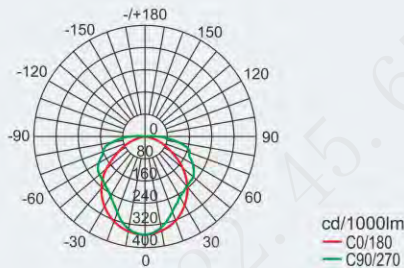

BAY51-Q LED 80 □□

Lamp power (W)	Luminous flux	Wattage
80	10300lm	87W

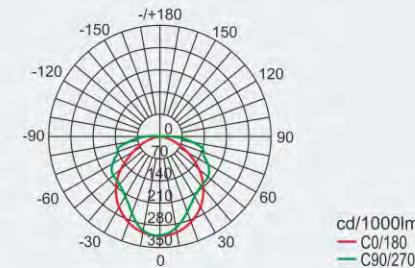

Dimension drawings (all dimensions in mm) - subject to alteration

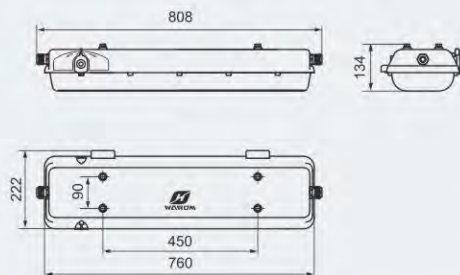

Type I

BAY51-Q LED 14×□□, BAY51-Q LED 14×□□J
BAY51-Q LED 9×□□
BAY51-Q LED 20□, BAY51-Q LED 20□J
BAY51-Q LED 40□

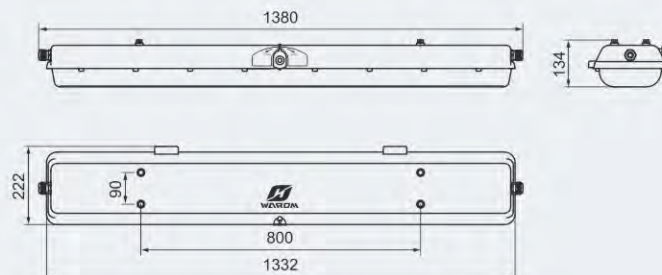

Type II

BAY51-Q LED 28×□□, BAY51-Q LED 28×□□J
BAY51-Q LED 18×□□, BAY51-Q LED 40□□J
BAY51-Q LED 60□, BAY51-Q LED 60□J
BAY51-Q LED 80□, BAY51-Q LED 80□J

Light Fittings for Fluorescent Lamp BAY51-Q LED Series Explosion-proof Light Fittings

Mounting type (all dimensions in mm) – subject to alteration

Installation reference

D: pendant chain type

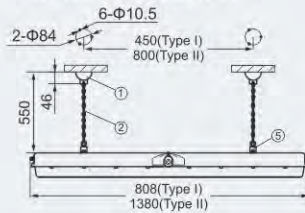

G: pendant pole type

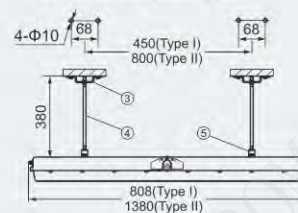

L: pole type (the pole is provided by user)

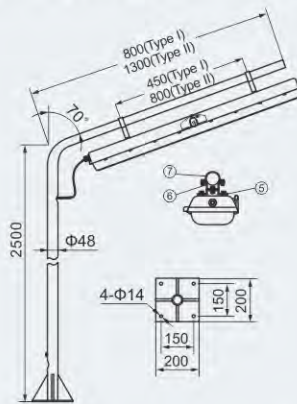

Suitable for ground pole type

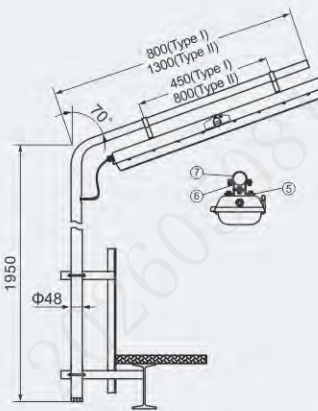

Suitable for fence pole type

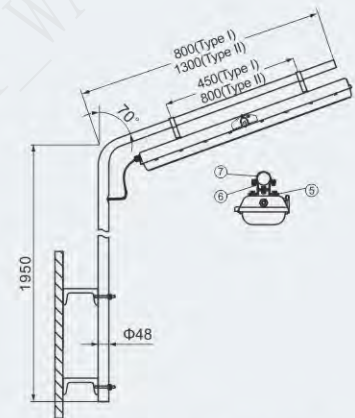

Suitable for wall pole type

X: ceiling type

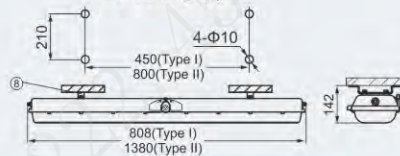

B: wall type

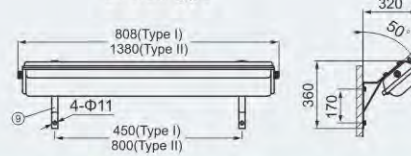

Mounting Accessories & Spare Parts Table

Supplied according to the mounting type

Mounting type	Name	Accessories		Ordering code	Weight (kg)
		Qty	Illustration		
D: pendant chain type	①.Sucker	2		5136017	0.15
	②.Chain	2	Length: 450mm	5136016	0.08
	⑤.Mounting bracket	2	Stainless steel, same as pendant pole type	5136030	0.07
G: pendant pole type	③.Mounting bracket	2		51S01G1	0.04
	④.M8 Screw	2	Stainless steel, length: 350mm	51S01G2	0.12
	⑤.Mounting bracket	2		5136030	0.07

Note: Accessories not in the table shall be supplied by user.

Light Fittings for Fluorescent Lamp BAY51-Q LED Series Explosion-proof Light Fittings

Mounting Accessories & Spare Parts Table

Supplied according to the mounting type

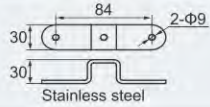
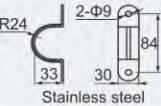
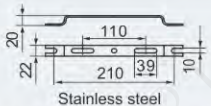
Mounting type	Accessories		Illustration	Ordering code	Weight (kg)
	Name	Qty			
L: pole type	⑥.Mounting bracket	2		5136012	0.04
	⑦.G1 1/2" Pipe clamp	2		5136014	0.04
	⑤.Mounting bracket	2	Stainless steel, same as pendant pole type	5136030	0.07
X: ceiling type	⑧.Mounting bracket	2		5136015	0.20
B: wall type	⑨.Wall bracket	2	Stainless steel, welded sheet steel	5136B02	0.62



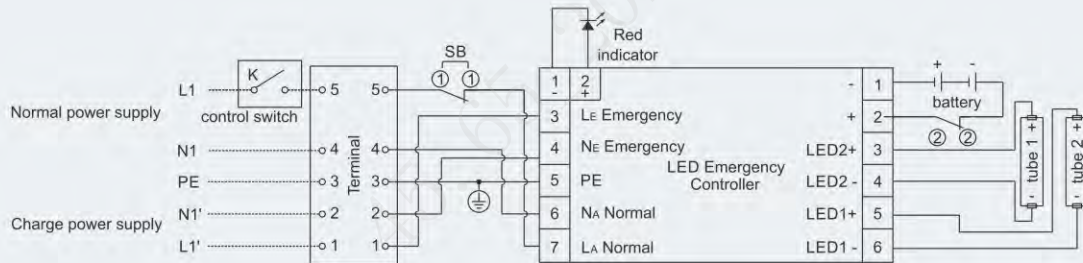

Note: Accessories not in the table shall be supplied by user.

Schematic diagram (BAY51-Q LED □ × □ □ J, LED tube)



Note: Tube for lamp 2 shall be default for single tube fittings.

Accessories

Picture	Name	Ordering code	Weight (kg)
	Explosion-proof distance switch	5136008	0.04
	HRB14-2C Explosion-proof LED driver (LED/14W)	5114001	1.30
	HRB28-2C Explosion-proof LED driver (LED/28W)	5128001	1.30
	HRE14-2C Explosion-proof LED emergency controller (LED/14W)	5114002	1.75
	HRE28-2C Explosion-proof LED emergency controller (LED/28W)	5128002	2.30
	BT8-9 Explosion-proof LED lamp tube (LED/9W)	51E0901	0.25
	BT8-18 Explosion-proof LED lamp tube (LED/18W)	51E1801	0.52
	BT8-14 Explosion-proof LED lamp tube (LED/14W)	5114003	0.18
	BT8-28 Explosion-proof LED lamp tube (LED/28W)	5128003	0.34

